

Specification

Z7

SSC		Customer
Drawn	Approval	Approval

[Contents]

1. Description	----- 3
2. Full code of Z7 series	----- 4
3. Outline dimension	----- 5
4. Characteristics of Z7	----- 6
5. Characteristic diagrams	----- 8
6. CIE Chromaticity Diagram	----- 15
7. Binning Table	----- 17
8. Labeling	----- 18
9. Reel Packing	----- 19
8. Recommended solder pad	----- 20
9. Soldering profile	----- 21
10. Precaution for Use	----- 22
11. Revision Profile	----- 24

Z7

Description

The Z-Power series is designed for high current operation and high flux output applications. It incorporates state of the art SMD design and low thermal resistant material.

The Z Power LED is ideal light sources for general illumination applications, custom designed solutions, automotive, large LCD backlights and high performance torches.

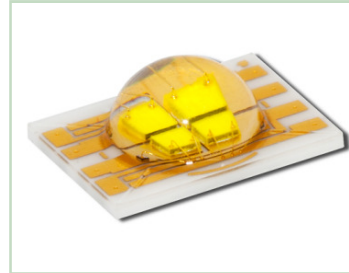

Z7

Features

- Super high Flux output and high Luminance
- Designed for high current operation
- SMT solderable
- Lead Free product
- RoHS compliant

Applications

- General Torch
- Architectural lighting
- Task lighting
- Decorative / Pathway lighting
- Remote / Solar powered lighting
- Street lighting

* The appearance and specifications of the product can be changed for improvement without notice.

Full code of Z7 series

1. Part Number Form : $X_1X_2X_3X_4X_5X_6X_7X_8 - X_9X_{10}X_{11}X_{12}X_{13}$

X_1	Company	S	SSC
X_2	Package series	Z	Z-Power
X_3	Color	W	Pure White
X_4		0	
X_5	Z-Power series number	7	Z7 series
X_6	Lens type	A	Dome-Wide
X_7	PCB type	0	Emitter
X_8	Revision No.	A	Rev0
X_9X_{10}	Luminous flux	-	-
$X_{11}X_{12}$	Color bin	-	-
X_{13}	Forward Voltage	-	-

2. Sticker Diagram on Reel & Aluminum Vinyl Bag

Rank : $X_9X_{10}X_{11}X_{12}X_{13}$



QUANTITY : 500



Lot No : #####



SSC PART NUMBER : $X_1X_2X_3X_4X_5X_6X_7X_8$



$X_1X_2X_3X_4X_5X_6X_7X_8$



Outline dimensions

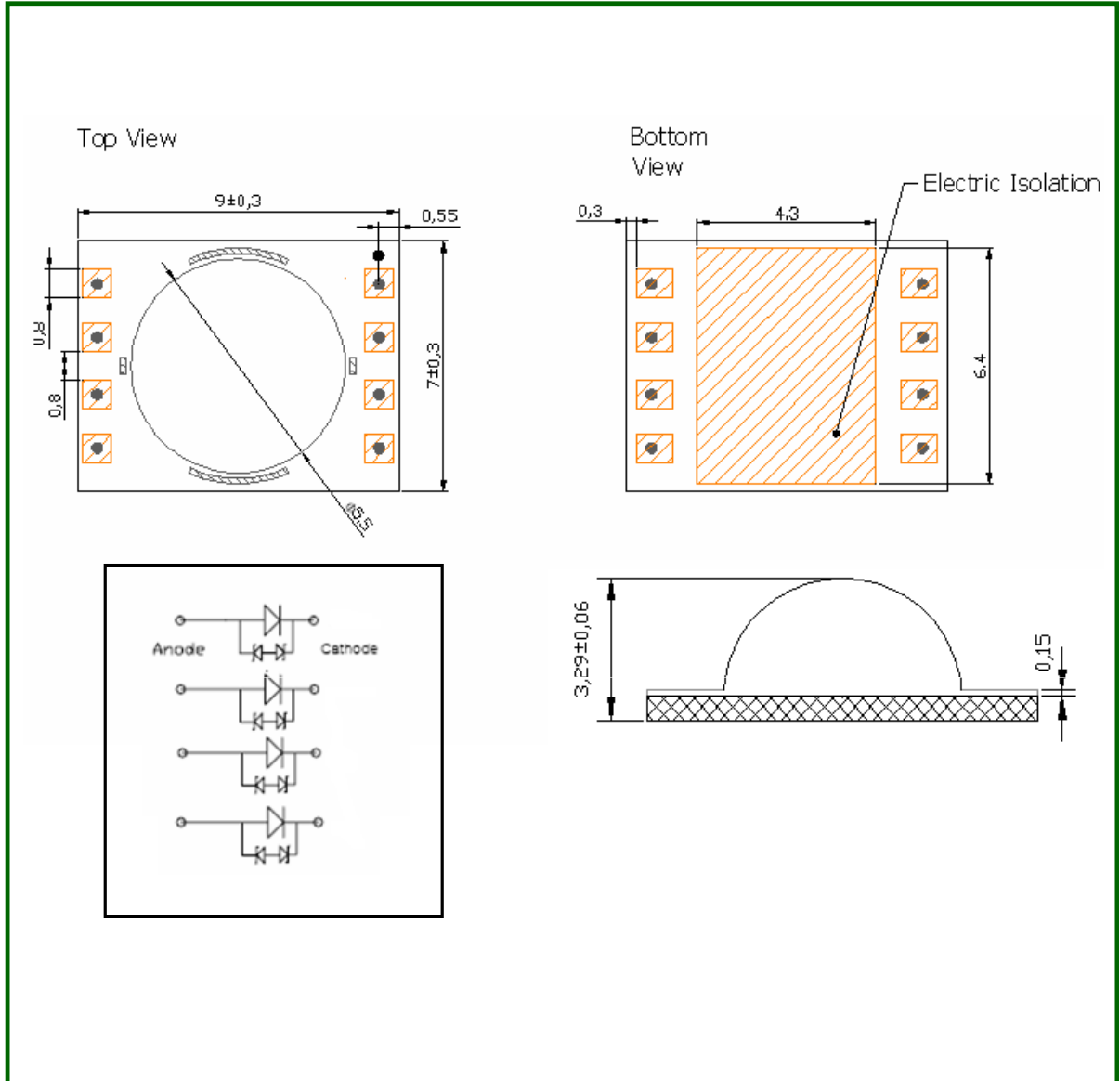

Notes :

- [1] All dimensions are in millimeters.
- [2] Scale : none
- [3] Undefined tolerance is $\pm 0.2\text{mm}$

Characteristics of Z7 (SZW07A0A)

1. Pure white

1-1 Electro-Optical characteristics at 1400mA

(Ta=25°C, RH30%)

Parameter	Symbol	Value			Unit
		Min	Typ	Max	
Luminous Flux [1]	Φ_V [2]	440	550	600	lm
Correlated Color Temperature [3]	CCT	4700	6000	8200	K
CRI	R_a	65	70	75	-
Forward Voltage [4]	V_F	-	3.3	4	V
Thermal resistance (J to S) [6]	$R\theta_{j-s}$	1.6			K/W
View Angle	$2\theta \frac{1}{2}$	130			deg.

1-2 Absolute Maximum Ratings

Parameter	Symbol	Value	Unit
Forward Current	I_F	2800 (each chip 700mA)	mA
Reverse Voltage	V	5	V
Power Dissipation	P_d	11	W
Junction Temperature	T_j	135	°C
Operating Temperature	T_{opr}	-40 ~ +85	°C
Storage Temperature	T_{stg}	-40 ~ +100	°C
ESD Sensitivity [5]	-	± 3,000V HBM	-

*Notes :

- [1] SSC maintains a tolerance of ±10% on flux and power measurements.
- [2] Φ_V is the total luminous flux output as measured with an integrating sphere.
- [3] Correlated Color Temperature is derived from the CIE 1931 Chromaticity diagram.
CCT ±5% tolerance.
- [4] Tolerance is ±0.06V on forward voltage measurements
- [5] A zener diode is included to protect the product from ESD.
- [6] At thermal Resistance, J to S means junction to solder point on metal PCB.

Characteristics of Z7 (SZWW7A0A)

1. Warm white

1-1 Electro-Optical characteristics at 1400mA

Parameter	Symbol	Value			Unit
		Min	Typ	Max	
Luminous Flux [1]	Φ_V [2]	340	450	500	lm
Correlated Color Temperature [3]	CCT	2600	3000	3500	K
CRI	R_a	-	80	-	-
Forward Voltage [4]	V_F	-	3.3	4	V
Thermal resistance (J to S) [6]	$R\theta_{J-S}$	1.6			K/W
View Angle	$2\theta \frac{1}{2}$	130			deg.

1-2 Absolute Maximum Ratings

Parameter	Symbol	Value	Unit
Forward Current	I_F	2800 (each chip 700mA)	mA
Reverse Voltage	V	5	V
Power Dissipation	P_d	11	W
Junction Temperature	T_j	135	°C
Operating Temperature	T_{opr}	-40 ~ +85	°C
Storage Temperature	T_{stg}	-40 ~ +100	°C
ESD Sensitivity [5]	-	± 3,000V HBM	-

*Notes :

- [1] SSC maintains a tolerance of ±10% on flux and power measurements.
- [2] Φ_V is the total luminous flux output as measured with an integrating sphere.
- [3] Correlated Color Temperature is derived from the CIE 1931 Chromaticity diagram.
CCT ±5% tolerance.
- [4] Tolerance is ±0.06V on forward voltage measurements
- [5] A zener diode is included to protect the product from ESD.
- [6] At thermal Resistance, J to S means junction to solder point on metal PCB.

Color Spectrum

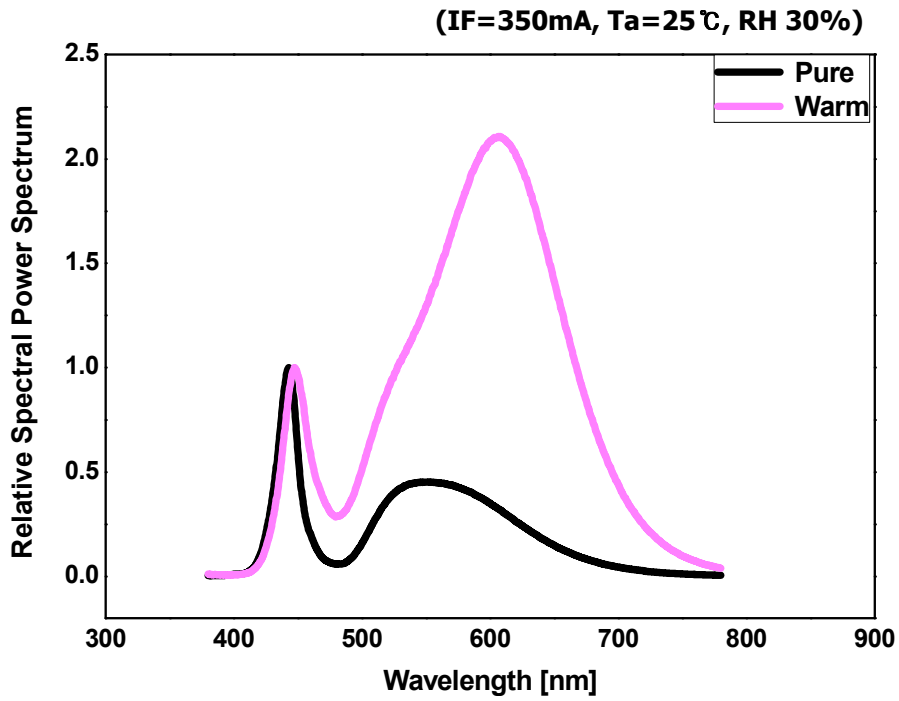

Forward Current Characteristics

Forward Voltage vs. Forward Current, Ta=25 °C

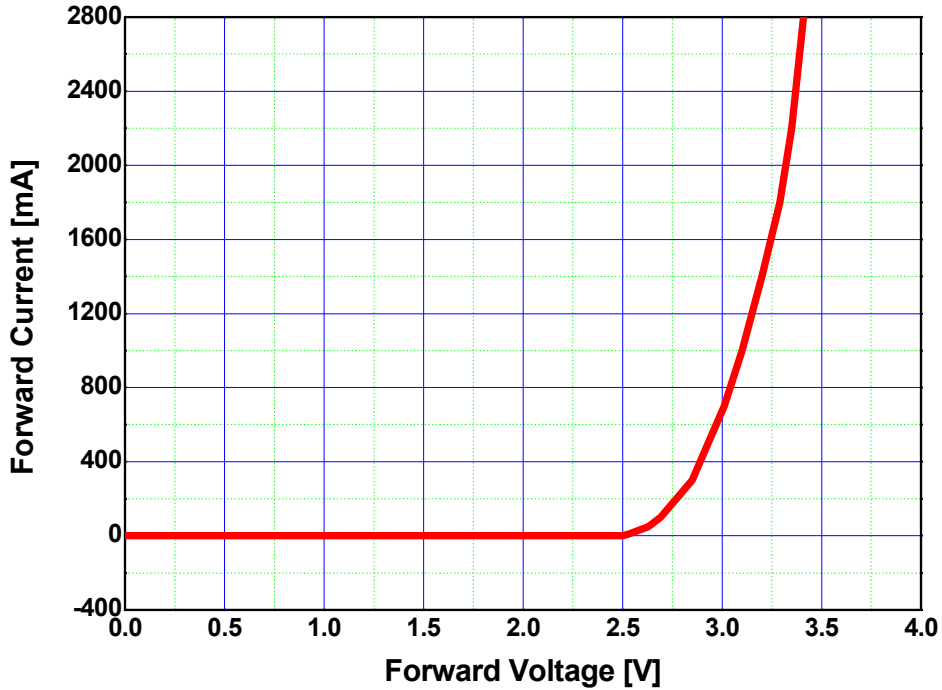

Forward Current vs. Normalized Relative Luminous Flux, Ta=25 °C

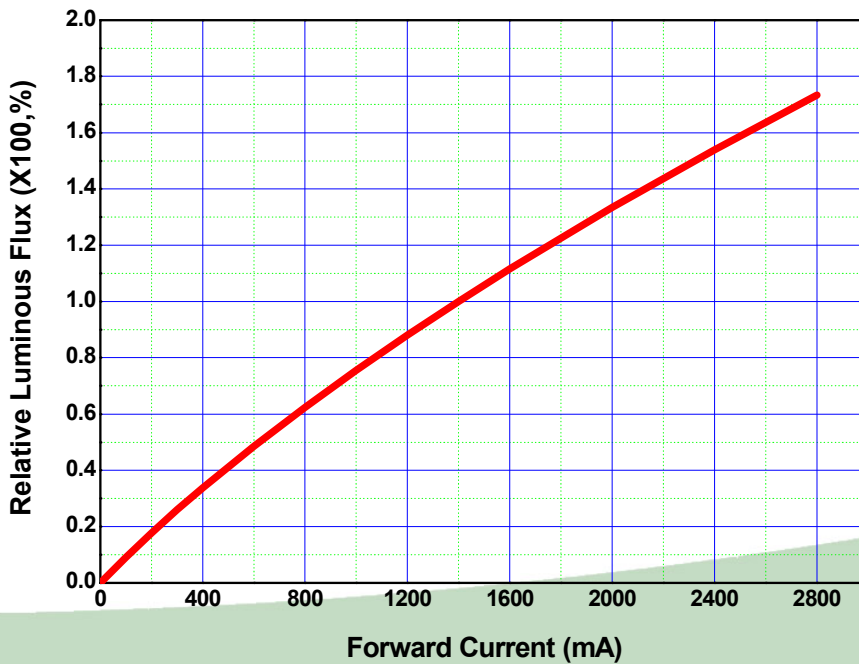

Chromaticity Coordinate vs. Forward Current, Ta=25°C

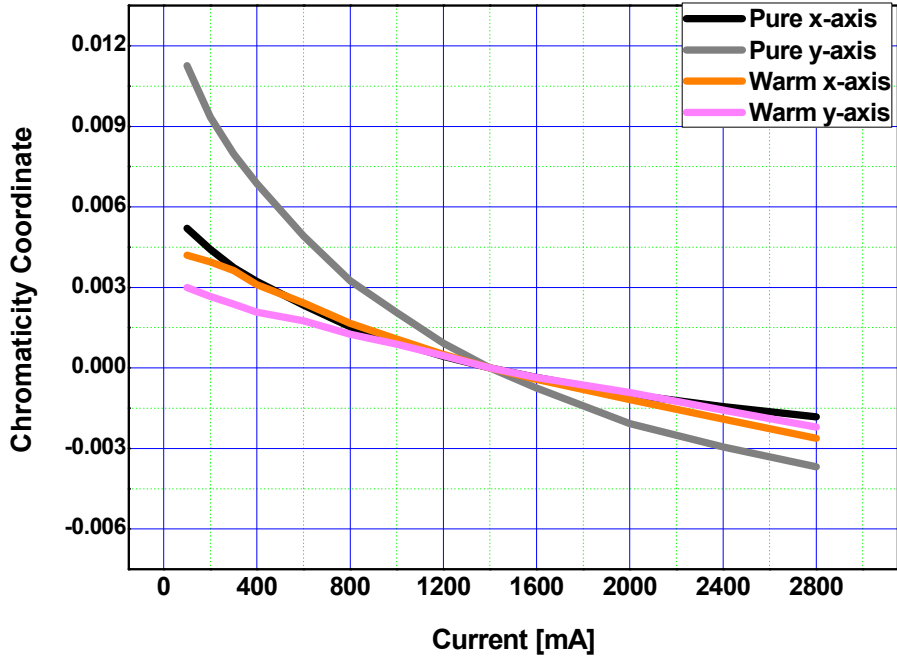

CCT vs. Forward Current, Ta=25°C

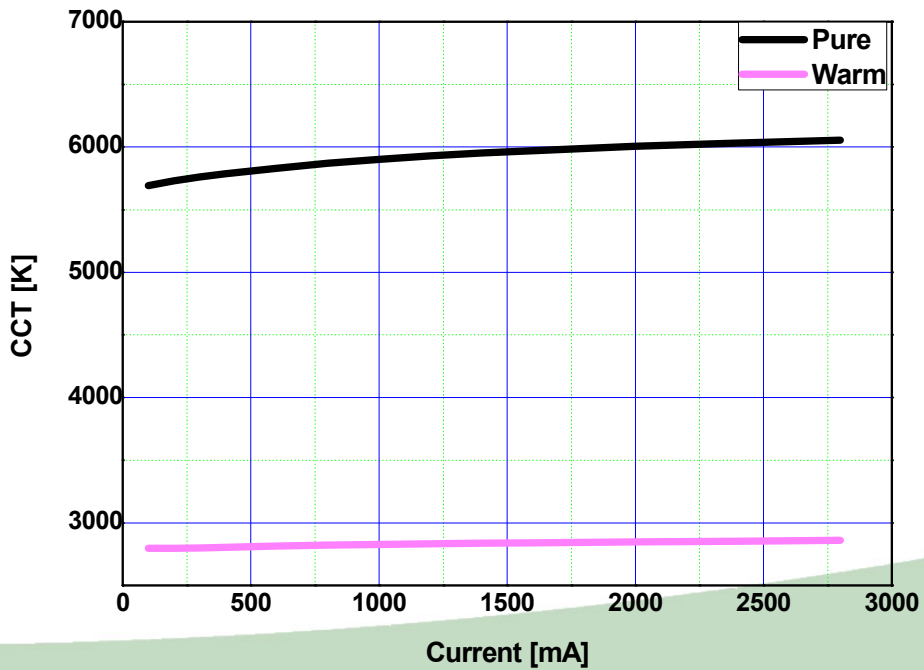

Junction Temperature Characteristics

Relative Light Output vs. Junction Temperature at IF=1400mA

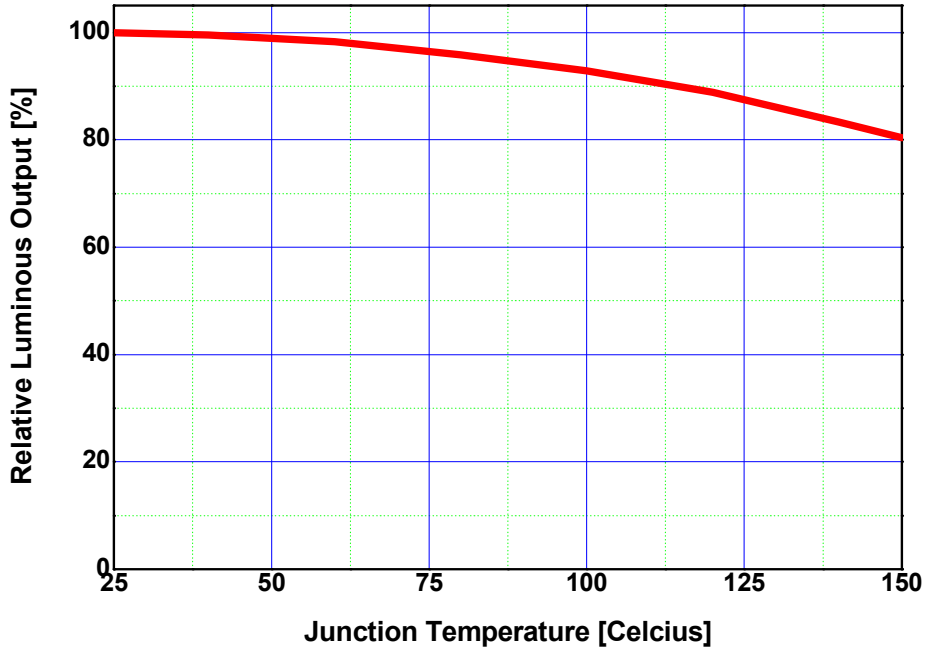

VF vs. Junction Temperature at IF=350mA

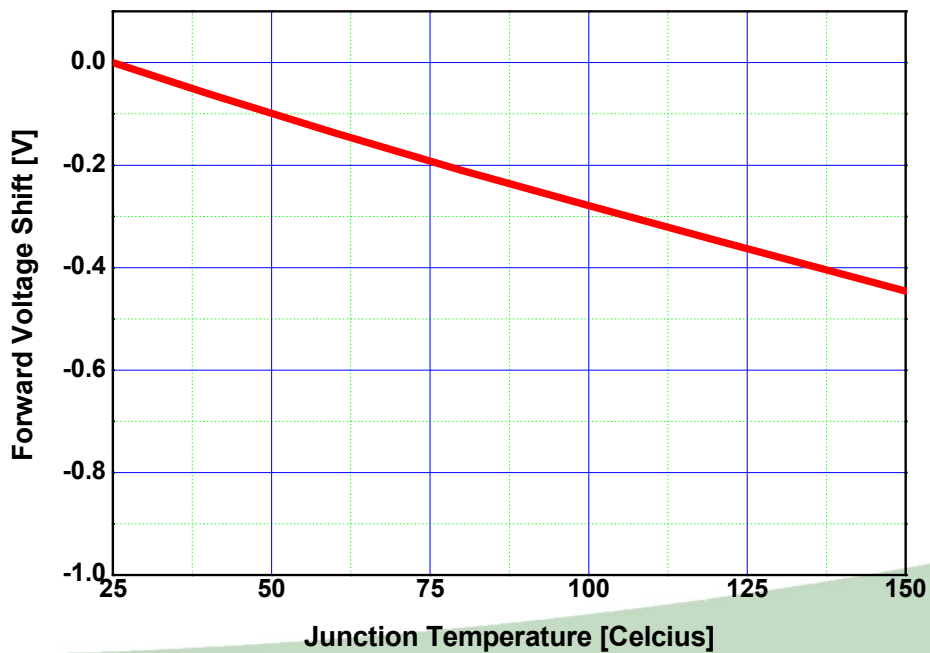

Chromaticity Coordinate vs. Junction Temperature at IF=350mA

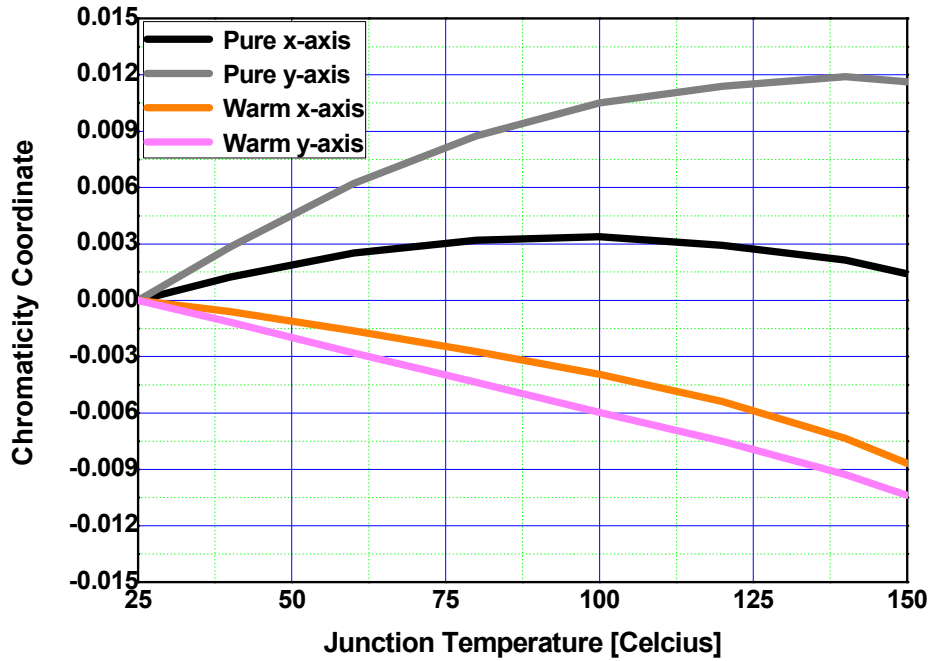

CCT vs. Junction Temperature at IF=350mA

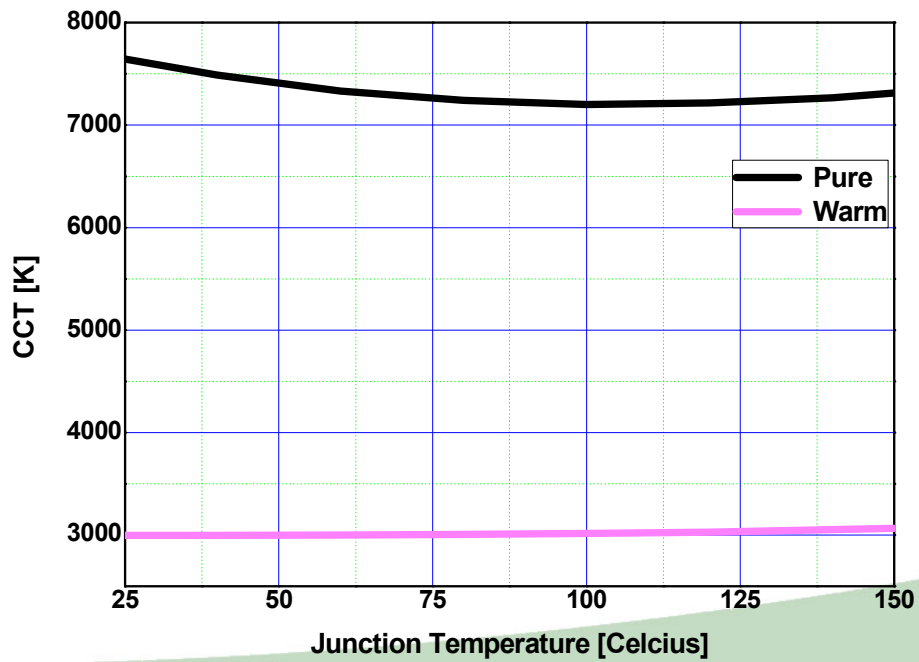

Ambient Temperature vs. Allowable Forward Current @1400mA

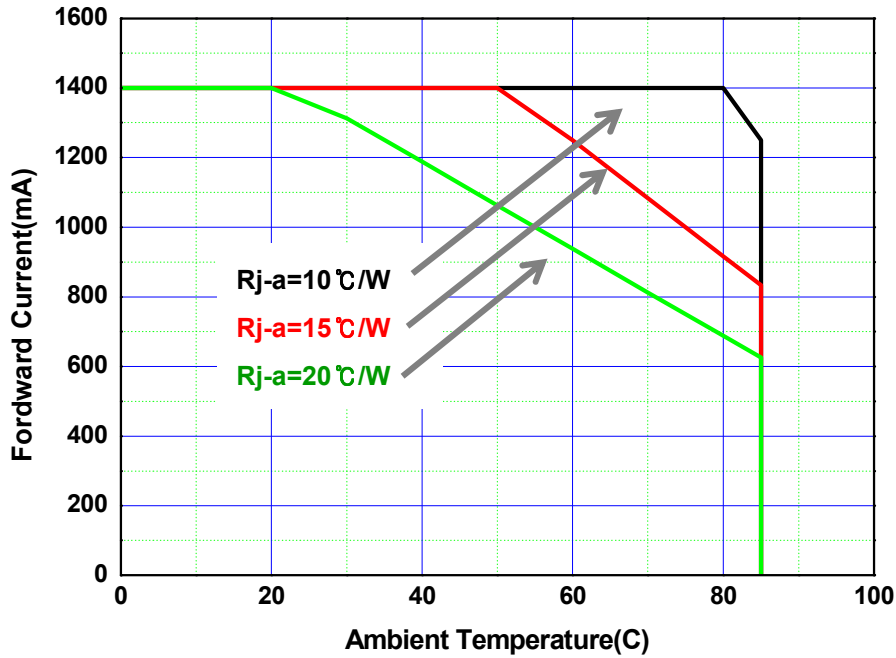

Ambient Temperature vs. Allowable Forward Current @2800mA

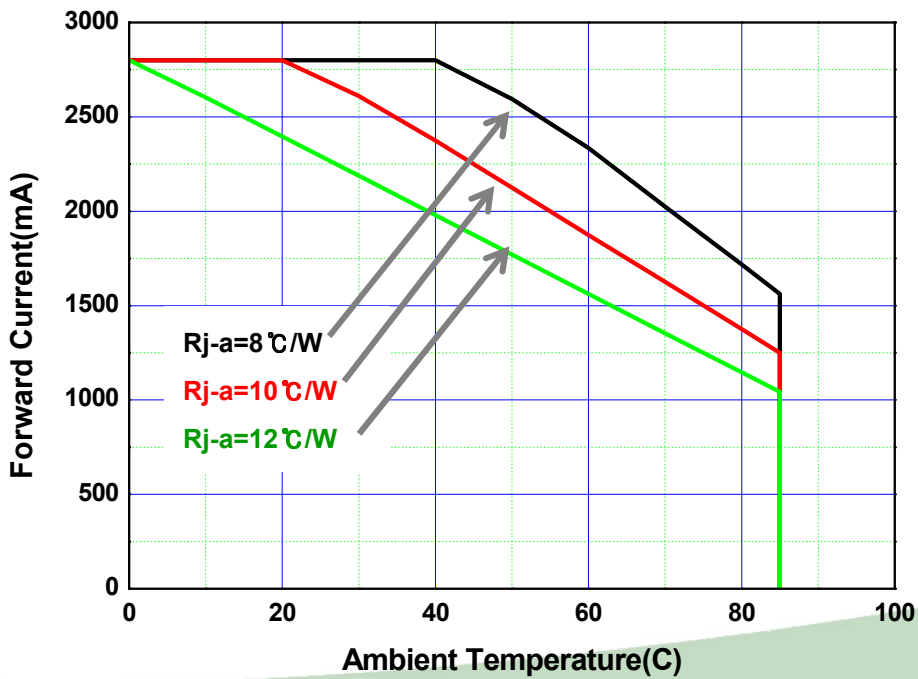

Radiation pattern @1400mA

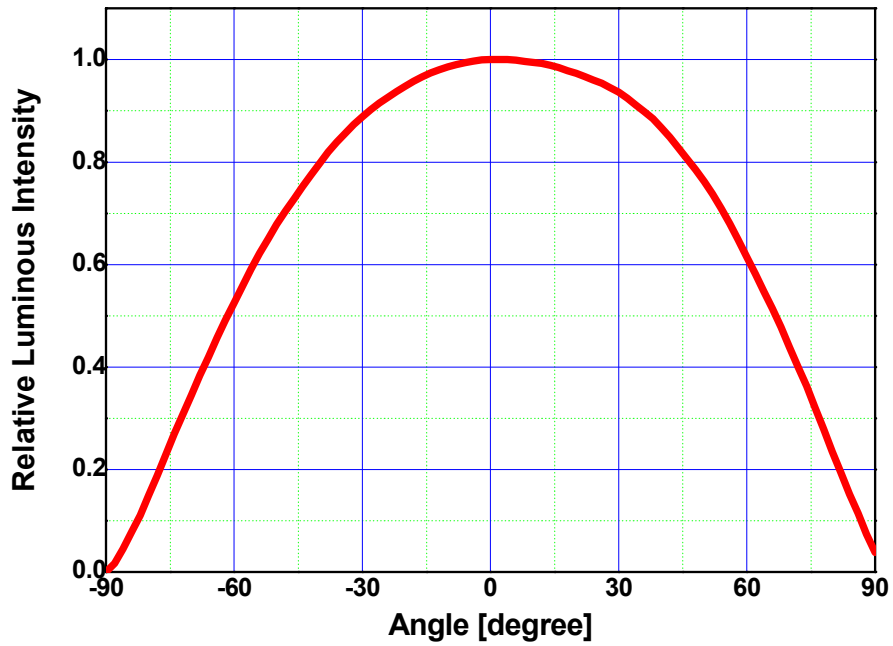

CIE Chromaticity Diagram (Pure)

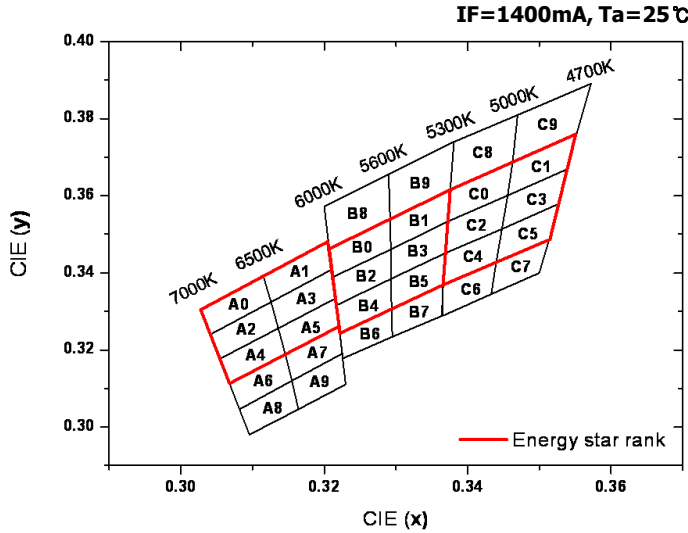

A0		A2		A4		A6		A8	
CIE x	CIE y	CIE x	CIE y	CIE x	CIE y	CIE x	CIE y	CIE x	CIE y
0.3028	0.3304	0.3041	0.3240	0.3055	0.3177	0.3068	0.3113	0.3082	0.3046
0.3041	0.3240	0.3055	0.3177	0.3068	0.3113	0.3082	0.3046	0.3096	0.2980
0.3126	0.3324	0.3136	0.3256	0.3146	0.3187	0.3155	0.3120	0.3164	0.3046
0.3115	0.3393	0.3126	0.3324	0.3136	0.3256	0.3146	0.3187	0.3155	0.3120
A1		A3		A5		A7		A9	
CIE x	CIE y	CIE x	CIE y	CIE x	CIE y	CIE x	CIE y	CIE x	CIE y
0.3115	0.3393	0.3126	0.3324	0.3136	0.3256	0.3146	0.3187	0.3155	0.3120
0.3126	0.3324	0.3136	0.3256	0.3146	0.3187	0.3155	0.3120	0.3164	0.3046
0.3210	0.3408	0.3216	0.3334	0.3221	0.3261	0.3225	0.3190	0.3230	0.3110
0.3205	0.3481	0.3210	0.3408	0.3216	0.3334	0.3221	0.3261	0.3225	0.3190
B8		B0		B2		B4		B6	
CIE x	CIE y	CIE x	CIE y	CIE x	CIE y	CIE x	CIE y	CIE x	CIE y
0.3200	0.3572	0.3207	0.3462	0.3212	0.3389	0.3217	0.3316	0.3222	0.3243
0.3207	0.3462	0.3212	0.3389	0.3217	0.3316	0.3222	0.3243	0.3226	0.3178
0.3292	0.3539	0.3293	0.3461	0.3293	0.3384	0.3294	0.3306	0.3295	0.3234
0.3290	0.3656	0.3292	0.3539	0.3293	0.3461	0.3293	0.3384	0.3294	0.3306
B9		B1		B3		B5		B7	
CIE x	CIE y	CIE x	CIE y	CIE x	CIE y	CIE x	CIE y	CIE x	CIE y
0.3290	0.3656	0.3292	0.3539	0.3293	0.3461	0.3293	0.3384	0.3294	0.3306
0.3292	0.3539	0.3293	0.3461	0.3293	0.3384	0.3294	0.3306	0.3295	0.3234
0.3376	0.3616	0.3373	0.3534	0.3369	0.3451	0.3366	0.3369	0.3364	0.3288
0.3381	0.3740	0.3376	0.3616	0.3373	0.3534	0.3369	0.3451	0.3366	0.3369
C8		C0		C2		C4		C6	
CIE x	CIE y	CIE x	CIE y	CIE x	CIE y	CIE x	CIE y	CIE x	CIE y
0.3381	0.3740	0.3376	0.3616	0.3373	0.3534	0.3369	0.3451	0.3366	0.3369
0.3376	0.3616	0.3373	0.3534	0.3369	0.3451	0.3366	0.3369	0.3364	0.3288
0.3463	0.3687	0.3456	0.3601	0.3448	0.3514	0.3440	0.3428	0.3433	0.3345
0.3470	0.3810	0.3463	0.3687	0.3456	0.3601	0.3448	0.3514	0.3440	0.3428
C9		C1		C3		C5		C7	
CIE x	CIE y	CIE x	CIE y	CIE x	CIE y	CIE x	CIE y	CIE x	CIE y
0.3470	0.3810	0.3463	0.3687	0.3456	0.3601	0.3448	0.3514	0.3440	0.3428
0.3463	0.3687	0.3456	0.3601	0.3448	0.3514	0.3440	0.3428	0.3433	0.3345
0.3552	0.3760	0.3539	0.3669	0.3526	0.3578	0.3514	0.3487	0.3500	0.3400
0.3572	0.3891	0.3552	0.3760	0.3539	0.3669	0.3526	0.3578	0.3514	0.3487

CIE Chromaticity Diagram (Warm)

IF=1400mA, Ta=25℃

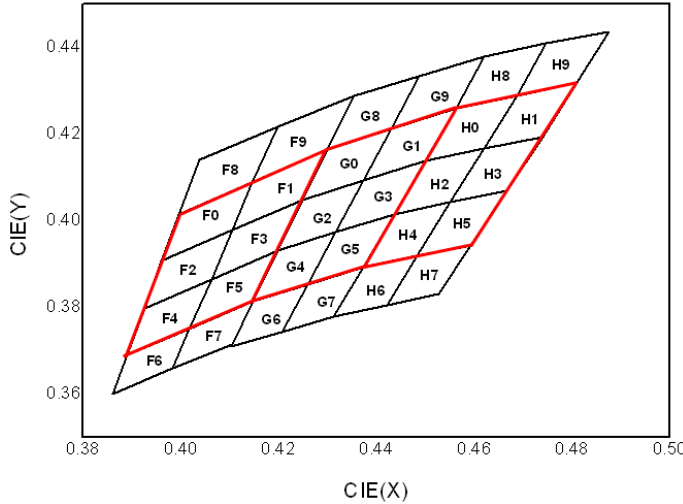

F0		F1		F2		F3		F4		F5	
CIE x	CIE y	CIE x	CIE y	CIE x	CIE y	CIE x	CIE y	CIE x	CIE y	CIE x	CIE y
0.3996	0.4015	0.4146	0.4089	0.3960	0.3907	0.4104	0.3978	0.3925	0.3798	0.4062	0.3865
0.3960	0.3907	0.4104	0.3978	0.3925	0.3798	0.4062	0.3865	0.3889	0.3690	0.4017	0.3751
0.4104	0.3978	0.4248	0.4048	0.4062	0.3865	0.4198	0.3931	0.4017	0.3751	0.4147	0.3814
0.4146	0.4089	0.4299	0.4165	0.4104	0.3978	0.4248	0.4048	0.4062	0.3865	0.4198	0.3931
0.3996	0.4015	0.4146	0.4089	0.3960	0.3907	0.4104	0.3978	0.3925	0.3798	0.4062	0.3865
F6		F7		F8		F9		G0		G1	
CIE x	CIE y	CIE x	CIE y	CIE x	CIE y	CIE x	CIE y	CIE x	CIE y	CIE x	CIE y
0.3889	0.3690	0.4017	0.3751	0.4037	0.4140	0.4197	0.4217	0.4299	0.4165	0.4430	0.4212
0.3860	0.3600	0.3983	0.3660	0.3996	0.4015	0.4146	0.4089	0.4248	0.4048	0.4374	0.4093
0.3983	0.3660	0.4104	0.3715	0.4146	0.4089	0.4299	0.4165	0.4374	0.4093	0.4499	0.4138
0.4017	0.3751	0.4147	0.3814	0.4197	0.4217	0.4354	0.4288	0.4430	0.4212	0.4562	0.4260
0.3889	0.3690	0.4017	0.3751	0.4037	0.4140	0.4197	0.4217	0.4299	0.4165	0.4430	0.4212
G2		G3		G4		G5		G6		G7	
CIE x	CIE y	CIE x	CIE y	CIE x	CIE y	CIE x	CIE y	CIE x	CIE y	CIE x	CIE y
0.4248	0.4048	0.4374	0.4093	0.4198	0.3931	0.4317	0.3973	0.4147	0.3814	0.4259	0.3853
0.4198	0.3931	0.4317	0.3973	0.4147	0.3814	0.4259	0.3853	0.4102	0.3710	0.4207	0.3744
0.4317	0.3973	0.4436	0.4015	0.4259	0.3853	0.4373	0.3893	0.4207	0.3744	0.4312	0.3778
0.4374	0.4093	0.4499	0.4138	0.4317	0.3973	0.4436	0.4015	0.4259	0.3853	0.4373	0.3893
0.4248	0.4048	0.4374	0.4093	0.4198	0.3931	0.4317	0.3973	0.4147	0.3814	0.4259	0.3853
G8		G9		H0		H1		H2		H3	
CIE x	CIE y	CIE x	CIE y	CIE x	CIE y	CIE x	CIE y	CIE x	CIE y	CIE x	CIE y
0.4354	0.4288	0.4487	0.4333	0.4562	0.4260	0.4687	0.4289	0.4499	0.4138	0.4620	0.4166
0.4299	0.4165	0.4430	0.4212	0.4499	0.4138	0.4620	0.4166	0.4436	0.4015	0.4551	0.4042
0.4430	0.4212	0.4562	0.4260	0.4620	0.4166	0.4740	0.4194	0.4551	0.4042	0.4666	0.4069
0.4487	0.4333	0.4619	0.4378	0.4687	0.4289	0.4810	0.4319	0.4620	0.4166	0.4740	0.4194
0.4354	0.4288	0.4487	0.4333	0.4562	0.4260	0.4687	0.4289	0.4499	0.4138	0.4620	0.4166
H4		H5		H6		H7		H8		H9	
CIE x	CIE y	CIE x	CIE y	CIE x	CIE y	CIE x	CIE y	CIE x	CIE y	CIE x	CIE y
0.4436	0.4015	0.4551	0.4042	0.4373	0.3893	0.4483	0.3919	0.4619	0.4378	0.4747	0.4410
0.4373	0.3893	0.4483	0.3919	0.4312	0.3778	0.4422	0.3805	0.4562	0.4260	0.4687	0.4289
0.4483	0.3919	0.4593	0.3944	0.4422	0.3805	0.4527	0.3830	0.4687	0.4289	0.4810	0.4319
0.4551	0.4042	0.4666	0.4069	0.4483	0.3919	0.4593	0.3944	0.4747	0.4410	0.4875	0.4435
0.4436	0.4015	0.4551	0.4042	0.4373	0.3893	0.4483	0.3919	0.4619	0.4378	0.4747	0.4410

Binning Table

Bin Code		
Luminous Flux (lm) @ $I_F = 1400\text{mA}$	Color Chromaticity Coordinate @ $I_F = 1400\text{mA}$	Forward Voltage (V) @ $I_F = 1400\text{mA}$
V2	C2	H



Luminous Flux (lm) @ $I_F = 1400\text{mA}$		
Bin Code	Min.	Max.
Z1	340	390
Z2	390	440
A1	440	490
A2	490	540
B1	540	590
B2	590	640

Color Chromaticity Coordinate @ $I_F = 1400\text{mA}$		
Bin Code	Min.	Max.
Ref. 15, 16 pages		

Forward Voltage (V) @ $I_F = 1400\text{mA}$		
Bin Code	Min.	Max.
G	2.75	3.00
H	3.0	3.25
I	3.25	3.5
J	3.5	3.75
K	3.6	3.8

 Available ranks

Label

Rank :	$X_9X_{10}X_{11}X_{12}X_{13}$
	
QUANTITY : 500	
	
Lot No : #####	
	
SSC PART NUMBER : SZW07A0A	
	
SZDW7A0A	
	

Full code form :

$X_1X_2X_3X_4X_5X_6X_7X_8$

- X_1 : Company
- X_2 : Z-Power LED series number
- X_3X_4 : Color
- X_5 : Series number
- X_6 : Lens type
- X_7 : PCB type
- X_8 : Revision number

Rank

$X_9X_{10}X_{11}X_{12}X_{13}$

- X_9X_{10} : Luminous Flux : LF [lm]
- $X_{11}X_{12}$: Color Coordinates : x, y
- X_{13} : Forward Voltage : VF [V]

Emitter Carrier & Reel Packaging

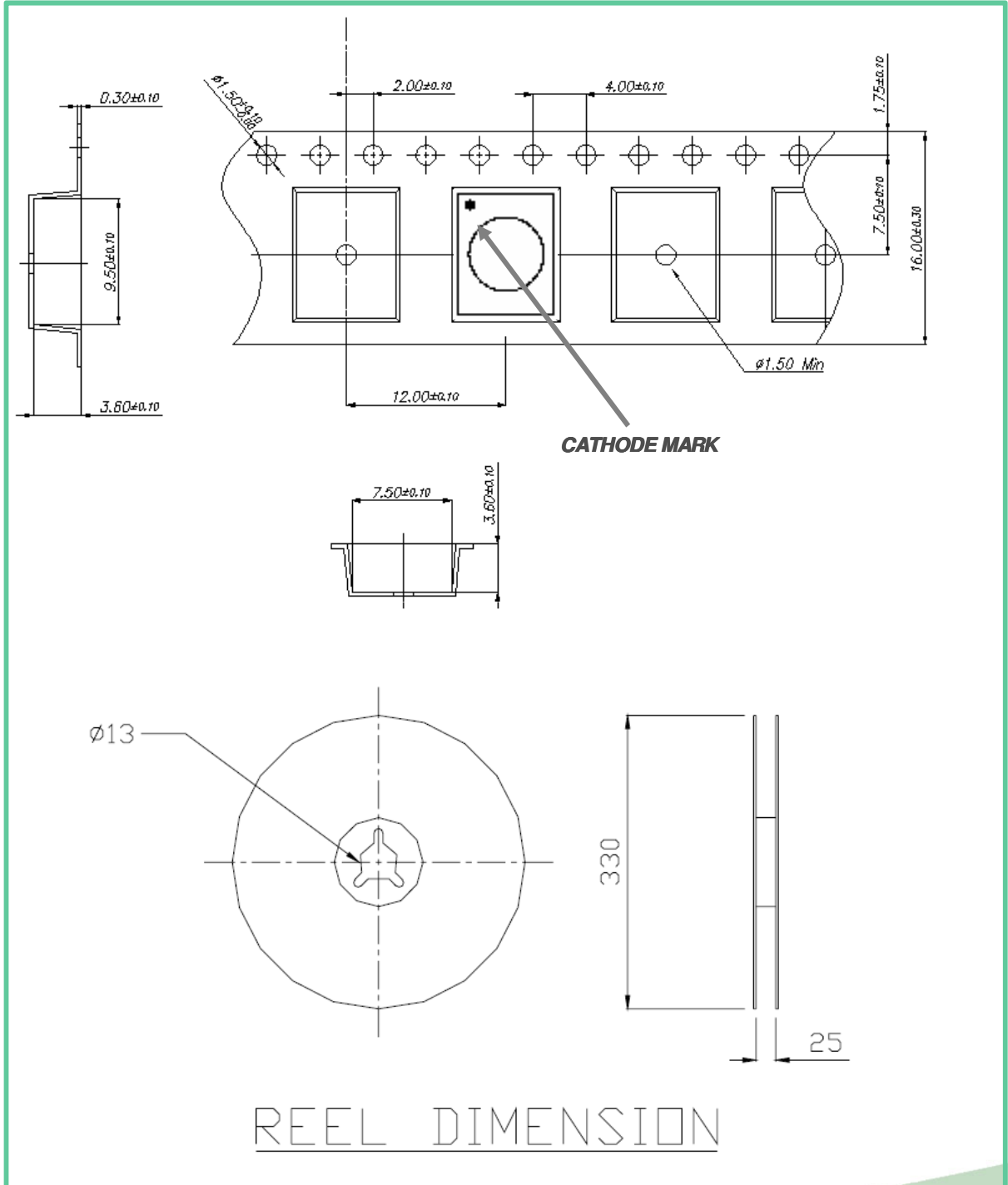

Recommended solder pad

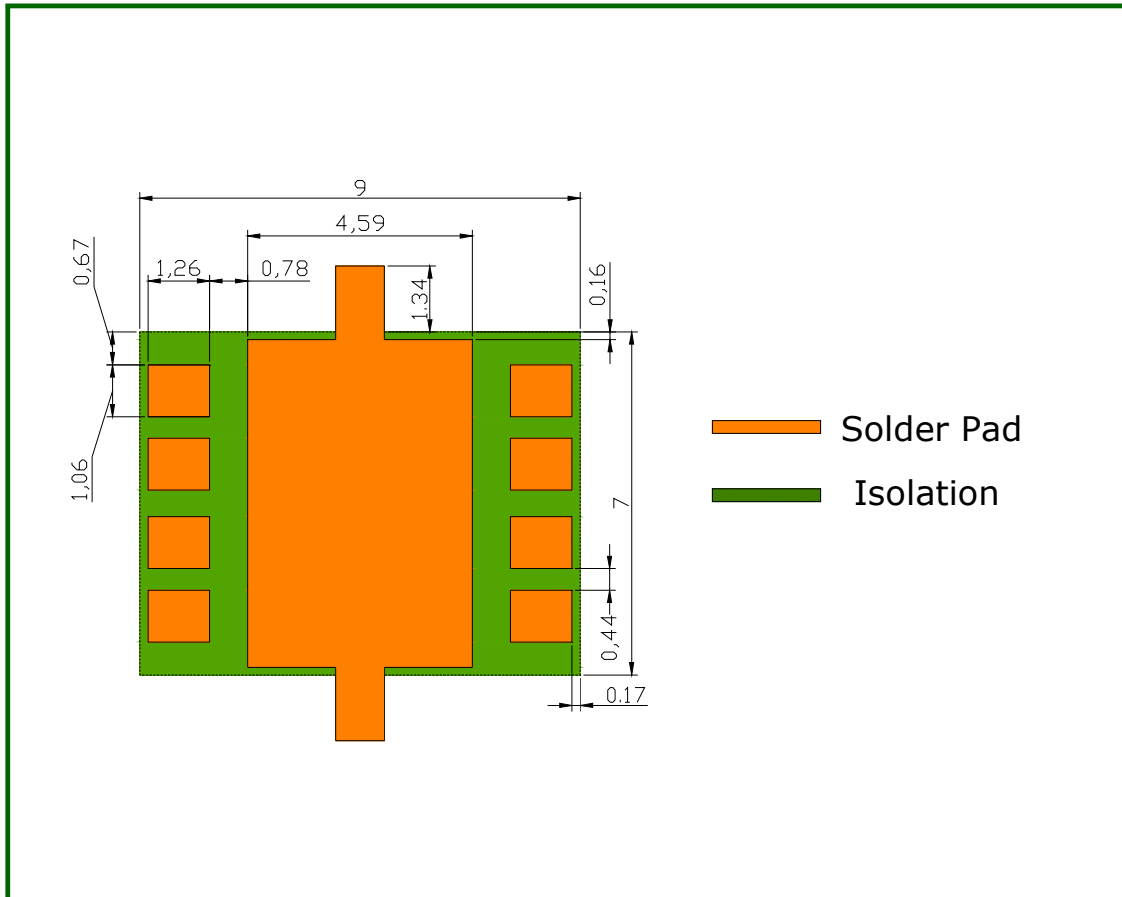

Notes :

- [1] All dimensions are in millimeters.
- [2] Scale : none
- [3] This drawing without tolerances are for reference only
- [4] Recommended solder paste height : $\geq 30\mu\text{m}$**

Reflow Soldering Conditions / Profile

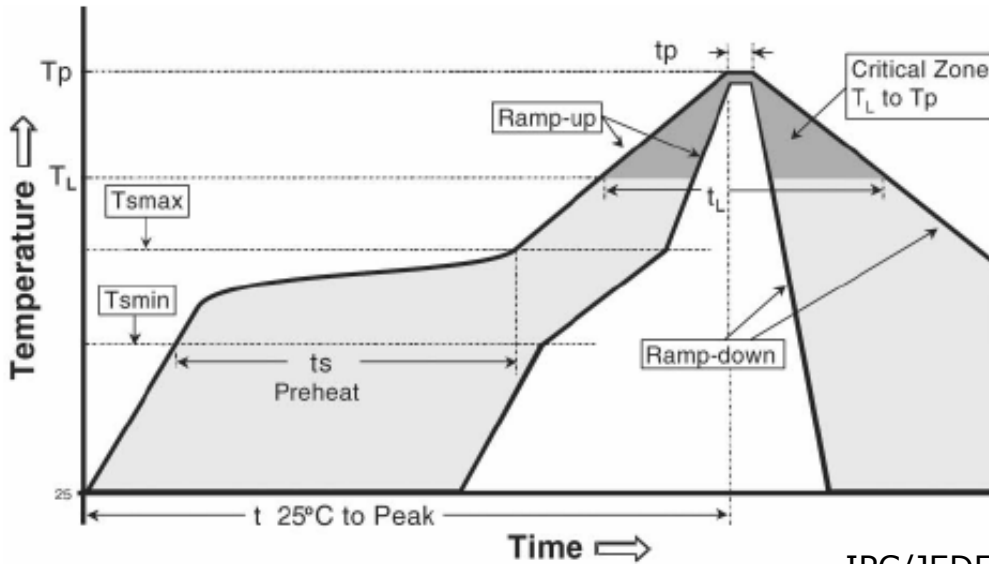

IPC/JEDEC J-STD-020C

Profile Feature	Sn-Pb Eutectic Assembly	Pb-Free Assembly
Average ramp-up rate (Tsmax to Tp)	3° C/second max.	3° C/second max.
Preheat - Temperature Min (Tsmmin) - Temperature Max (Tsmmax) - Time (Tsmmin to Tsmmax) (ts)	100 °C 150 °C 60-120 seconds	150 °C 200 °C 60-180 seconds
Time maintained above: - Temperature (TL) - Time (tL)	183 °C 60-150 seconds	217 °C 60-150 seconds
Peak Temperature (Tp)	215 °C	260 °C
Time within 5°C of actual Peak Temperature (tp)2	10-30 seconds	20-40 seconds
Ramp-down Rate	6 °C/second max.	6 °C/second max.
Time 25°C to Peak Temperature	6 minutes max.	8 minutes max.

*** Caution**

1. Reflow soldering should not be done more than one time.
2. Repairs should not be done after the LEDs have been soldered. When repair is unavoidable, suitable tools must be used.
3. Die slug is to be soldered.
4. When soldering, do not put stress on the LEDs during heating.
5. After soldering, do not warp the circuit board.
6. Recommend to use a convection type reflow machine with 7 ~ 8 zones.

Precaution for use

- Storage

To avoid the moisture penetration, we recommend storing Z Power LEDs in a dry box with a desiccant . The recommended storage temperature range is 5C to 30C and a maximum humidity of 50%.

- Use Precaution after Opening the Packaging

Use proper SMD techniques when the LED is to be soldered dipped as separation of the lens may affect the light output efficiency.

Pay attention to the following:

a. Soldering should be done immediately after opening the package (within 24Hrs).

b. Required conditions after opening the package

- Sealing

- Temperature : 5 ~ 40℃ Humidity : less than 30%

c. If the package has been opened more than 1 week or the color of the desiccant changes, components should be dried for 10-12hr at 60±5℃

- Do not apply mechanical force or excess vibration during the cooling process to normal temperature after soldering.

- Do not rapidly cool device after soldering.

- Components should not be mounted on warped (non coplanar) portion of PCB.

- Radioactive exposure is not considered for the products listed here in.

- Gallium arsenide is used in some of the products listed in this publication. These products are dangerous if they are burned or shredded in the process of disposal. It is also dangerous to drink the liquid or inhale the gas generated by such products when chemically disposed of.

- This device should not be used in any type of fluid such as water, oil, organic solvent and etc. When washing is required, IPA (Isopropyl Alcohol) should be used.

- When the LEDs are in operation the maximum current should be decided after measuring the package temperature.

- LEDs must be stored properly to maintain the device. If the LEDs are stored for 3 months or more after being shipped from SSC, a sealed container with a nitrogen atmosphere should be used for storage.

- The appearance and specifications of the product may be modified for improvement without notice.

- Long time exposure of sunlight or occasional UV exposure will cause lens discoloration.

- The slug is isolated from anode electrically.

Therefore, we recommend that you don't isolate the heat sink.

- Attaching LEDs, do not use adhesives that outgas organic vapor.

Handling of Silicone resin LEDs

The Z-Power LED is encapsulated with a silicone resin for the highest flux efficiency.

Notes for handling:

- Avoid touching silicone resin parts especially with sharp tools such as Pincette (Tweezers)
- Avoid leaving fingerprints on silicone resin parts.
- Silicone resin will attract dust so use covered containers for storage.
- When populating boards in SMT production, there are basically no restrictions regarding the form of the pick and place nozzle, except that excessive mechanical pressure on the surface of the resin must be prevented.
- It is not recommend to cover the silicone resin of the LEDs with other resin (epoxy, urethane, etc)
- Especially, if a reverse voltage is continuously applied to the product, such operation can cause the electro-migration resulting in LED damage.